

INTRODUCTION

ABOUT THIS MANUAL

Thank you for equipping your INEOS Grenadier with the RED Winches optional/accessory Winch.

The purpose of this Winch Manual is to explain the vehicle's Winch operation and to make the control of its systems easy to understand and secure to operate.

This Winch Owner's Manual, and warning labels attached to the Winch, are to serve as guidelines for hazard-free, operation. They should not be understood to prepare you for every possible situation.

The information in this manual is created for all variants of the Winch. Thus, it is possible that some of the information may not be applicable for your vehicle variant.

You must always comply with the specific laws and regulations of the country that you are in. These laws may differ from or be in addition to the information in this Winch Owner's Manual.

The advice given in this Winch Owner's Manual is for guidance only and is not intended to be an exhaustive list of appropriate actions in all circumstances. If in doubt, owners should consult an INEOS approved Partner.

WARNINGS, CAUTIONS AND NOTES

The following symbols are used within this Winch Owner's Manual to call your attention to specific types of information. The safety warnings are to ensure care is taken to follow instructions to avoid injury, or serious damage to the vehicle.



WARNING: Warnings provide awareness of procedures that need to be followed precisely. Failure to follow "WARNING" instructions may result in equipment damage, property damage, and/or personal injury.











CAUTION: Cautions provide awareness of possible damage to the equipment and/or vehicle. Failure to follow "CAUTION" instructions may result in equipment damage and/or property damage.



NOTE: Notes are provided to show procedures which will help avoid difficulties in the operation of your equipment and/or vehicle.

LEGALITIES

LEGALITIES

-  **WARNING:** The Winch installed to your vehicle, both option and/or accessory is a self-recovery Winch only and should never be used without prior training and extensive experience.
-  **WARNING:** It is your responsibility to ensure that before any Winch is operated you have conducted the necessary training and that the Winch has been correctly installed by a certified technician. Failure to do so can result in serious injury and/or death.
-  **WARNING:** This Winch Owners' Manual should only be referred to as a guide. It is the user's responsibility to ensure safe Winching practices and full maintenance of the Winch is followed.
-  **WARNING:** The Winch installed to your vehicle, both option and/or accessory is intended for self-recovery purposes only. Do not use the Winch for any other purpose. INEOS Automotive will not be held responsible for any damages, injuries and/or deaths that occur from or relating to the operation of the Winch outside of the intended purpose.
-  **WARNING:** Notwithstanding recommendations made in this handbook, INEOS Automotive will take no responsibility for any damages, injuries and/or deaths that occur from or relating to the operation of the Winch installed on the INEOS Grenadier.
-  **WARNING:** Unauthorised modifications made to the vehicle and/or Winch may void warranties and be unsafe. INEOS Automotive will take no responsibility for any damage, injuries and/or deaths that occur from or relating to any such modifications.
-  **WARNING:** It is recommended to always have two people when performing Winch pulls, one operating the vehicle and one observing the vehicle and surroundings monitoring external factors and risks.
-  **WARNING:** Whenever a Winch pull is conducted, there needs to be a minimum of two people at the location. This is to ensure help is at hand if something goes wrong or there is an injury to an individual. Seek immediate medical support if there is an injury as a result of using the Winch.

WINCH INTRODUCTION

WINCH INTRODUCTION

Every winching / recovery situation has the potential for personal injury. In order to minimize that risk, it is important to read this guide carefully before using the Winch.

Please familiarise yourself with the operation of your Winch before using it and be constantly safety oriented. In this guide we provide important safety information and instructions on how to use your Winch.

SAVE THIS MANUAL and other product literature found in this kit for future reference and review frequently for continued safe operation.

Instruct all users of the Winch to review this manual before operating the Winch.



WARNING: The advice given in this Winch Owner's Manual is for guidance only and is not intended to be an exhaustive list of appropriate actions in all circumstances. It should not be understood to prepare you for every possible situation.



WARNING: Read all product literature before attempting any Winch pulls.



WARNING: Always wear gloves when handling a Winch and/or related equipment.



WARNING: Always wear eye protection when operating a Winch and/or related equipment.

















WARNING: Be careful when operating the winch not to entangle any long hair and/or clothing in the Winch Rope. Take care not to entangle any jewelry and/or materials such as, rags in the Winch Rope, as it meets the Fairlead. Failure to do so may result in serious injury or even death.



WARNING: Whenever a Winch pull is conducted, there needs to be a minimum of two people at the location. This is to ensure help is at hand if something goes wrong or if there is an injury to an individual. You must seek immediate medical support if there is an injury as a result of using the Winch.

GENERAL SAFETY PRECAUTIONS

GENERAL SAFETY

-  WARNING: Never operate a vehicle Winch when under the influence of drugs, alcohol or medication.
-  WARNING: Never exceed the Winch or Winch Rope capacity listed on the product technical specifications. Reduce the Winch load wherever possible.
-  WARNING: Never exceed the loading limits of any piece of equipment acting within the Winch pull.
-  WARNING: Never use the Winch for towing.
-  WARNING: Never perform an off-centre Winch pull (side pulls).
-  WARNING: Winches can cause explosion/bursting hazards.
-  WARNING: Always inspect the Winch Rope, Winch Fairlead, winch controls and any supplementary winching equipment deemed necessary for the recovery before and after operating the winch.
-  WARNING: Never use damaged Winch Rope, including but not limited to Winch Ropes that are frayed, kinked, burnt or torn.
-  WARNING: Always replace damaged equipment before operation, to protect the user from serious injury and/or death.
-  WARNING: Always remove elements and/or obstacles that may interfere with safe Winch operation.
-  WARNING: Always assess environmental factors, available equipment and the applicable safe winching techniques before and during any Winch pulls.
-  WARNING: Always ensure anchoring elements are secure, will not slip or cause sudden movements and can exceed the intended Winching loads.
-  WARNING: Never engage or disengage the Winch Clutch if the Winch is loaded, the Winch Rope is under tension, or the Winch Drum is moving.
-  WARNING: Never touch the Winch Rope or any supplementary equipment being used, while the winch is loaded, or the Winch Rope is under tension.
-  WARNING: Never touch the Winch Rope or any supplementary equipment being used, while someone else is operating the Winch controls before, during or after a Winch pull.

GENERAL SAFETY PRECAUTIONS



WARNING: Always stand clear of the Winch Rope, vehicle and any other objects involved before, during and after the Winch pull.



WARNING: Always keep other people and animals away from the Winch Rope, vehicle and any other objects involved before, during and after the Winch pull.



WARNING: Always be aware of the vehicle and anchor stability before, during and after winching. Always ensure other personnel are in a safe location before starting the Winch operation.



WARNING: Immediately alert all personnel of any unstable condition.



WARNING: Always secure a load after a Winch pull with supplementary equipment.



WARNING: Never leave the remote control where it can be activated during free spooling, pull set up, or when the Winch is not being used.



WARNING: Always alert operators and other personnel when the vehicle, anchor or any part of the Winch, the Winch Rope or any supplementary equipment is under tension and or the Winch Drum is moving.



CAUTION: Always replace damaged components before operation, to protect the equipment from further damage.



CAUTION: Always use the Winch Rope together with RED Winches compatible Snatch Ring (S-Ring 50).



CAUTION: Never hook a Winch Rope back on to itself.



CAUTION: Ensure Winch Clutch (Freespool Lever) is correctly engaged or disengaged, before attempting a Winch pull.

ENTANGLEMENT HAZARD



WARNING: Failure to adhere to the instructions could lead to serious injury and/or death.



WARNING: Always remove loose items of clothing and jewelry before operating winch.



WARNING: Always keep hands and clothing clear of the Winch Rope and Fairlead during operation, particularly when spooling in or out.

GENERAL SAFETY PRECAUTIONS



WARNING: Always use extreme caution when handling the Winch Rope during spooling operations.



WARNING: Never allow the Winch Rope to slip through your hands.

FALLING OR CRUSHING HAZARD



WARNING: Never use a Winch to lift or move people and/or animals.



WARNING: Winches (and related equipment) may have the ability to cause cuts or pierce hands.



WARNING: Never use a Winch as a hoist or to suspend a load.



WARNING: Always be aware of potentially hot surfaces including, but not limited to the Winch Motor, Winch Drum and Winch Rope both during and after Winch use.



WARNING: Always check the Winch Rope is attached securely and not slipping on the Winch Drum.

ELECTRICAL SAFETY



WARNING: When viewed from the DRIVER seat, do not spool the Winch out further than the red marker. Beyond this point the Plasma Lock will not create sufficient friction.



WARNING: Winches can cause fires and burn hazards.



WARNING: Never operate the Winch if the Plasma Lock is not correctly tensioned.



WARNING: Never use a Winch with damaged cabling.



WARNING: Exposed cabling and terminals can cause electric shocks. Monitor Winch cabling for damage.



CAUTION: Avoid installing electrical cables around pinch and wear/abrasion points.

CUT AND BURN HAZARD



WARNING: Always wear heavy duty gloves when handling the Winch Rope.

CAUTION: Never route electrical cabling across sharp edges.

GENERAL SAFETY PRECAUTIONS



CAUTION: Never route electrical cabling through or near moving parts.

WINCH VARIANTS

WINCH VARIANTS

The Winch is a RED Winches designed and manufactured product, whose designs have undergone extensive testing.

Integrated Heavy Duty Winch - 5.5 Tonnes (Optional)

- Low Mount (Motor) Style Winch.
- Single Motor.
- 12v DC.
- Manual Freespool Lever.
- 208mm length Winch Drum.
- Chromium molybdenum gears (1230N/mm²).
- Rated pull: 5,500kg from bottom layer of Winch Rope.
- OX Winch Motor.
- Winch Remote Control.

Removable Rear Winch 3.5 Tonnes (Accessory)

- Low Mount (Motor) Style Winch.
- Single Motor.
- 12v DC.
- Manual Freespool Lever.
- 208mm length Winch Drum.
- Chromium molybdenum gears (1230N/mm²).

- Rated pull: 3,500kg from bottom layer of Winch Rope.
- OX Winch Motor.
- Winch Remote Control.

WINCH OPERATION - PLASTIC FRONT BUMPER (OPTION)

Built into the Front Bumper of the Grenadier, there are two set-ups, dependant on the territory your vehicle is homologated to.

Integrated Heavy Duty Winch - 5.5 Tonnes (Optional)

Plastic Front Bumper (EU Regions)



WARNING: Ensure all winch accessories and/or devices attached to the Winch Rope have been removed, before returning to public roads.



WARNING: Never use the Front Integrated Heavy Duty Winch and Removable Rear Winch (if fitted), at the same time.



WARNING: Do not use a Winch, if there are any signs of wear to the Winch Rope. Using a damaged Winch Rope can result in damage to the vehicle, injury or death to the operator and others nearby.



CAUTION: Take care when removing the plastic winch cover.

WINCH VARIANTS



CAUTION: Always wind the Winch Rope over the top of the Winch Drum, on the Front Integrated Heavy Duty Winch.

If your vehicle is fitted with a Plastic Front Bumper (EU Regions), then your Front Integrated Heavy Duty Winch, is located behind a central plastic cover.

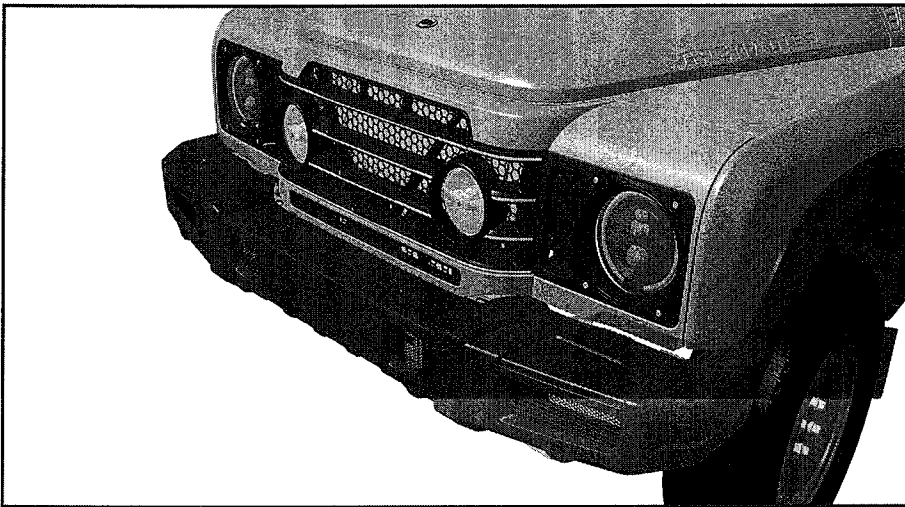

To access the Front Integrated Heavy Duty Winch on a vehicle with a Plastic Front Bumper, follow this procedure:

1. Park the vehicle in a safe and secure environment.
2. Remove the two upper screws on the plastic cover.

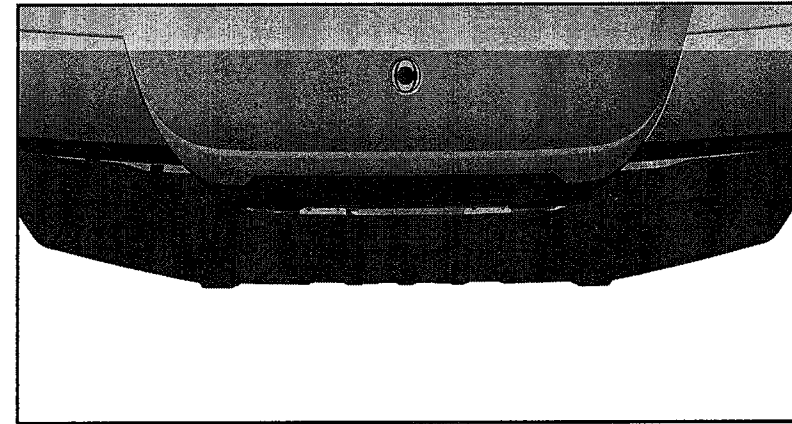

3. Remove the plastic cover and place it securely inside the vehicle.

WINCH VARIANTS

4. Inspect and remove any debris or material that may have collected around the Winch Fairlead before commencing any Winch operation.

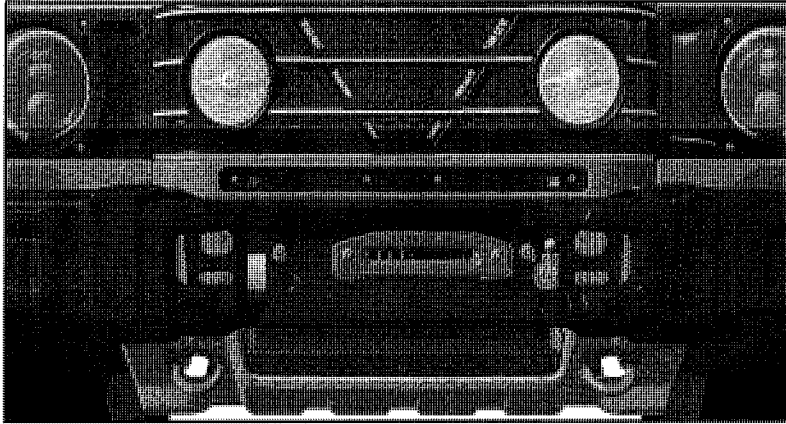

When the winching operation is complete, the plastic cover should be immediately re-installed using the following procedure:

1. Park the vehicle in a safe and secure environment.
2. Inspect and remove any debris or material that may have collected around the Winch Fairlead during the Winch operation.

3. Retrieve the plastic cover and fit it to the Front Bumper.

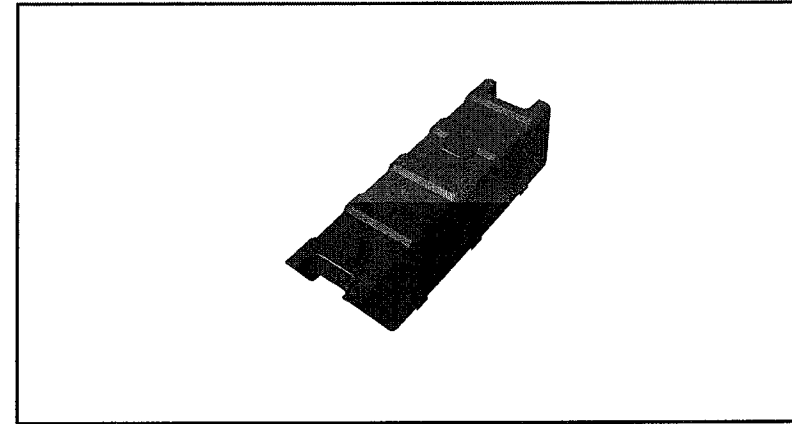

4. Install the two upper screws on the plastic cover.

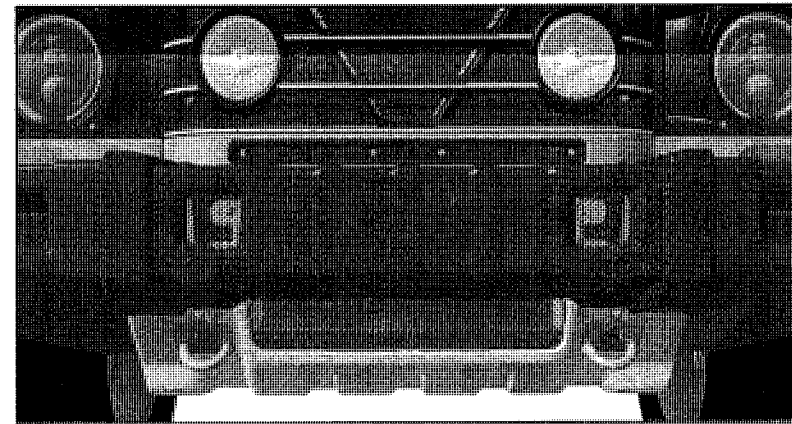

WINCH VARIANTS

5. Inspect and ensure the front numberplate is undamaged and secure, before driving on-road.



NOTE: When returning to public roads you must ensure the plastic winch cover is re-installed and secure, with the numberplate clearly visible.

WINCH OPERATION - STEEL FRONT BUMPER (OPTION)

Built into the front bumper of the Grenadier, there are two set-ups, dependant on the territory your vehicle is homologated to.

Integrated Heavy Duty Winch - 5.5 Tonnes (Optional)

Steel Front Bumper (RoW Regions):



WARNING: Ensure all Winch accessories and or devices attached to the Winch Rope have been removed before returning to public roads.



WARNING: Never use the Front Integrated Heavy Duty Winch and Removable Rear Winch (if fitted) at the same time.



WARNING: Do not use a Winch, if there are any signs of wear to the Winch Rope. Using a damaged Winch Rope can result in damage to the vehicle, injury or death to the operator and others nearby.



CAUTION: Take care when moving the flip-up numberplate.



CAUTION: Always wind the Winch Rope over the top of the Winch Drum on the Front Integrated Heavy Duty Winch.

If your vehicle is fitted with a Steel Front Bumper (RoW Regions), then your Front Integrated Heavy Duty Winch is located behind the vehicles front numberplate.

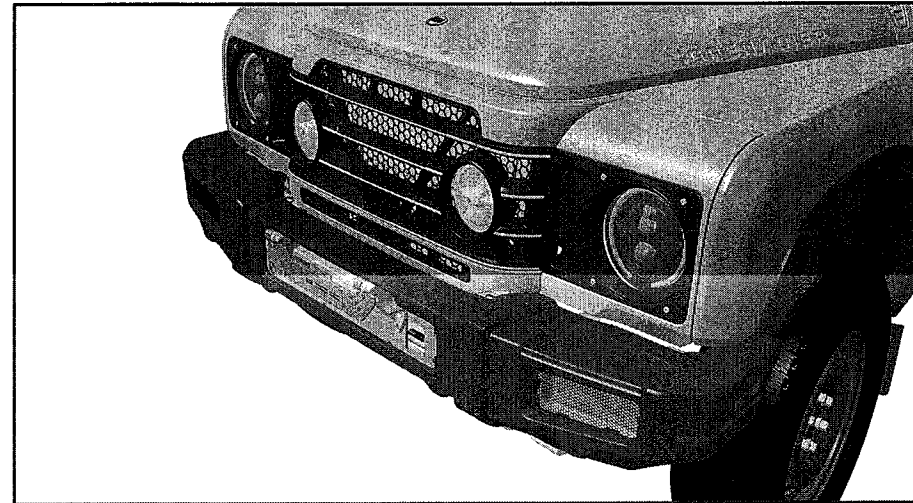

WINCH VARIANTS

To access the Front Integrated Heavy Duty Winch, on a vehicle with a Steel Front Bumper, follow this procedure:

1. Park the vehicle in a safe and secure environment.
2. Push the numberplate and the bracket to the side.

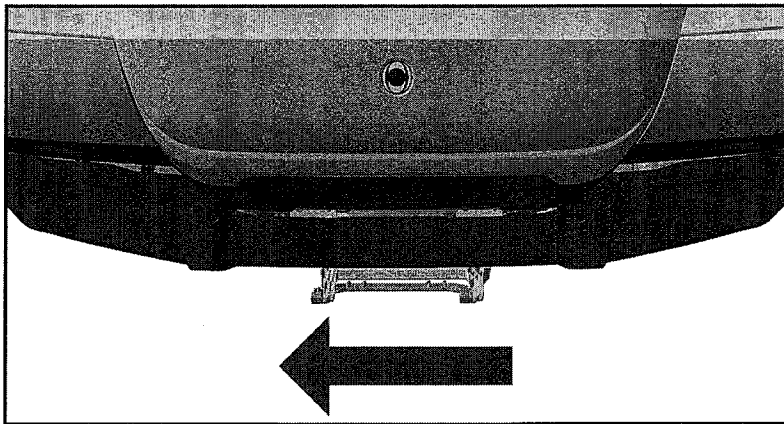

3. Rotate the numberplate and bracket up and clear of the winch Fairlead.
4. Ensure the spring-loaded mechanism of the numberplate and bracket is returned to the opposite side to lock in place.

5. Inspect and remove any debris or material that may have collected around the Winch Fairlead, before commencing any Winch operation.

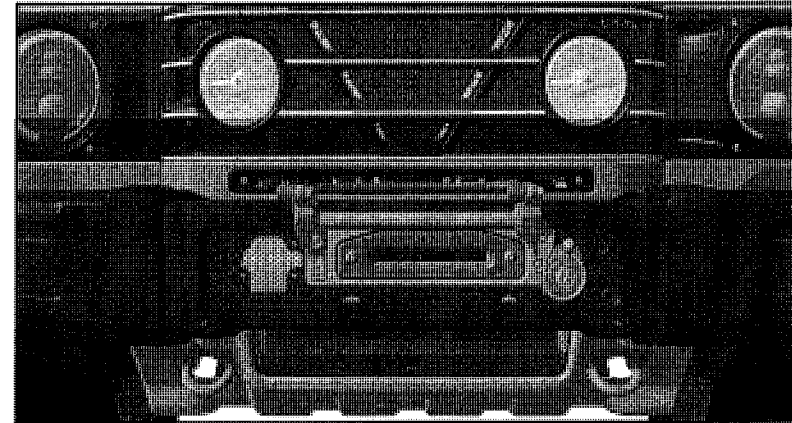

When the winching operation is complete, the numberplate and bracket should immediately be returned to their on-road state using the following procedure:

1. Park the vehicle in a safe and secure environment.
2. Push the numberplate and the bracket to the side.

WINCH VARIANTS

3. Rotate the numberplate and the bracket down, so that the numberplate and bracket cover the Fairlead and are in a fully visible state for on-road driving.

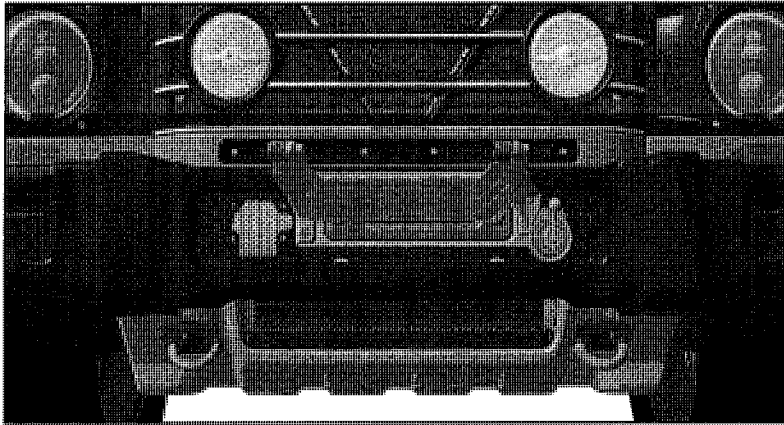

4. Ensure the spring-loaded mechanism of the numberplate and bracket is returned to the opposite side to lock in place and the numberplate is secure in a vertical position.
5. Inspect and ensure the front numberplate is undamaged and secure, before driving on-road.



NOTE: Ensure the flip-up numberplate has been returned to its vertical position, before returning to

public roads. The numberplate must be secure and clearly visible.

WINCH OPERATION - REMOVABLE REAR WINCH (ACCESSORY)

Available as an easy install accessory, the vehicle can be fitted with a Removable Rear Winch.



WARNING: Care must be taken when removing, lifting, and securing the Removable Rear Winch. The Winch weighs approximately 42kg. Ensure correct lifting methods are employed and that all cables and locking pins have been correctly removed or installed.





WARNING: The Removable Rear Winch, should not be fitted to the front of any vehicle.





WARNING: You must ensure that the Removable Rear Winch, is properly secured with the appropriate ties/ fixings while in transit. Incidents happen when drivers underestimate how much restraint is needed to keep a load secure within the vehicle. Dynamic forces are much higher than static forces and more force is required to secure a load when it is moving (dynamic) than when it is stationary (static). Storage should be as low as possible in the vehicle and you should ensure that there is no movement when the Winch is secured. Failure to secure the Winch properly can result in serious injury and/or death.

WINCH VARIANTS

 **WARNING:** Do not transport the Removable Rear Winch on the roof or with any other external fixings.

 **WARNING:** Never use the Front Integrated Heavy Duty Winch and the Removable Rear Winch (if fitted) at the same time.

 **CAUTION:** Always wind the Winch Rope under the bottom of the Winch Drum on the Removable Rear Winch.

 **CAUTION:** When driving the vehicle off-road with the Removable Rear Winch installed, the departure angle is reduced.

Mounting into the 2" Receiver on the Vertical Towing Interface, this Winch is easy to install and remove when necessary.

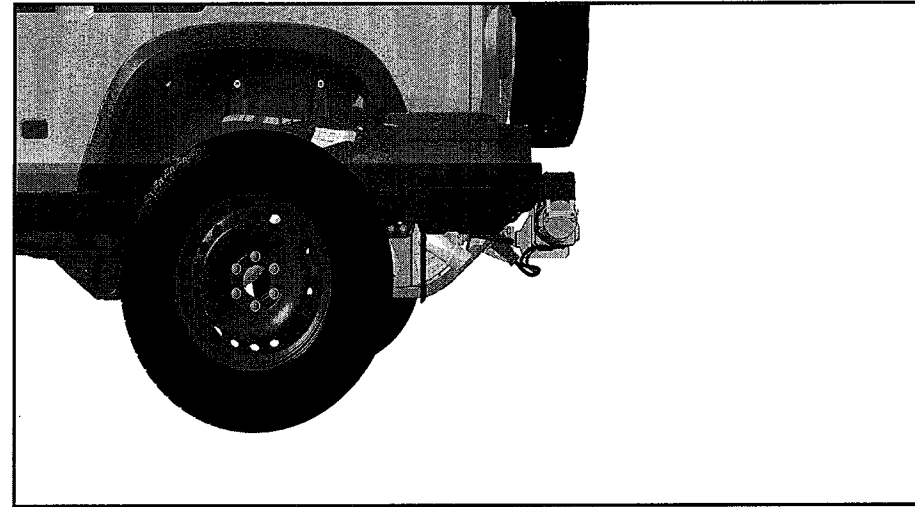

 **NOTE:** It is illegal in some markets, to drive on public roads with the Removable Rear Winch mounted to the Vertical Towing Interface. When transitioning from off-road to on-road, the Removable Rear Winch must be removed and securely stowed in the vehicle. Check with the local authority before driving on-road with the Removable Rear Winch mounted.

 **WARNING:** Ensure the Vertical Towing Interface has been correctly installed by a certified technician, before commencing any winching operations. Contact your INEC approved partner.

WINCH VARIANTS



WARNING: Never use a Winch with damaged cabling. Consult immediately with your INEOS approved partner.



WARNING: Do not use a Winch, if there are any signs of damage or wear to the Winch Rope. Using a damaged Winch Rope can result in further damage to the vehicle, injury or even death to the operator and others nearby.



WARNING: Do not remove any debris and/or mud from the rear high amp outlet (NATO outlet) until the power isolator has been switched off. Failure to do so can result in serious injury and/or death.

To use the Removable Rear Winch, follow this procedure:

1. Park the vehicle in safe and secure environment.
2. Remove any towing devices including tow balls.

3. Inspect and remove any debris from the 2" Receiver in the centre of the Vertical Towing Interface.

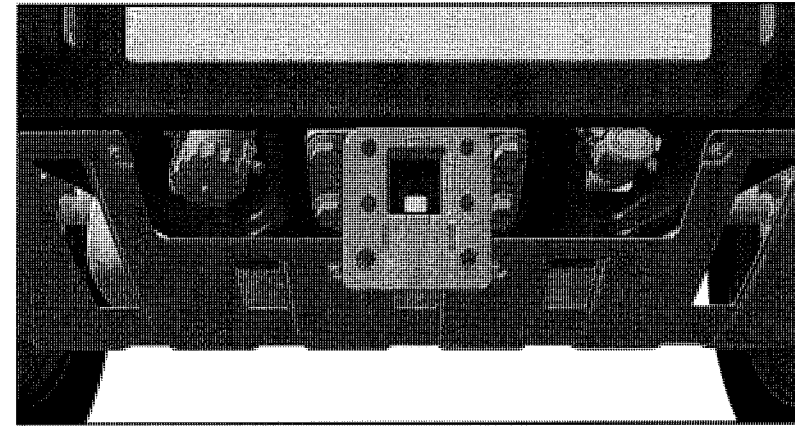

WINCH VARIANTS

4. Insert the Removable Rear Winch into the 2" Receiver, ensuring the locking pin is correctly installed and secure with the R-Clip.

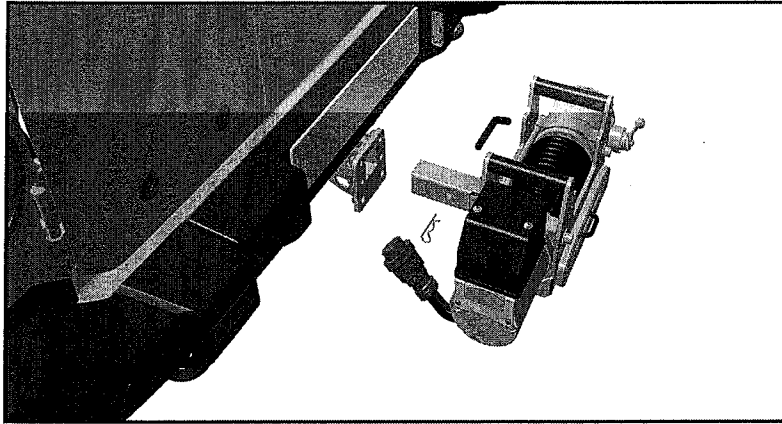

NOTE: To install the Removable Rear Winch, the Grenadier must be fitted with a Vertical Towing Interface.

5. Inspect Removable Rear Winch electrical cables for damage and wear.

6. Unscrew the NATO outlet cover, inspect and remove any debris from the outlet and insert the Removable Rear Winches power cable.

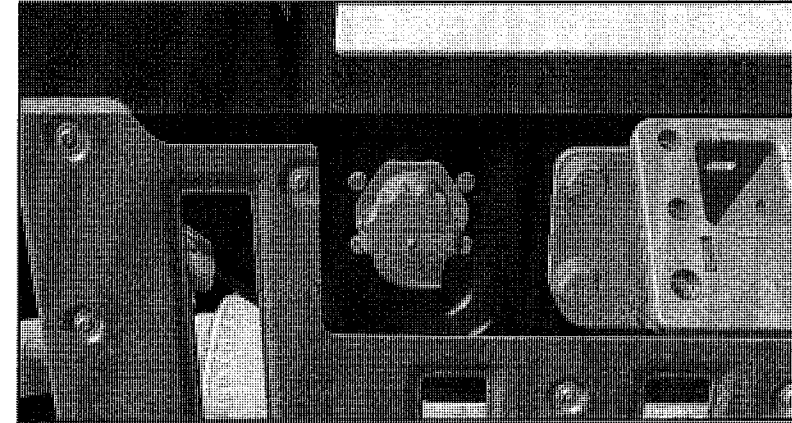

WINCH VARIANTS

7. Inspect and remove any debris or material that may have been collected around the Winch Fairlead, before commencing any Winch operation.

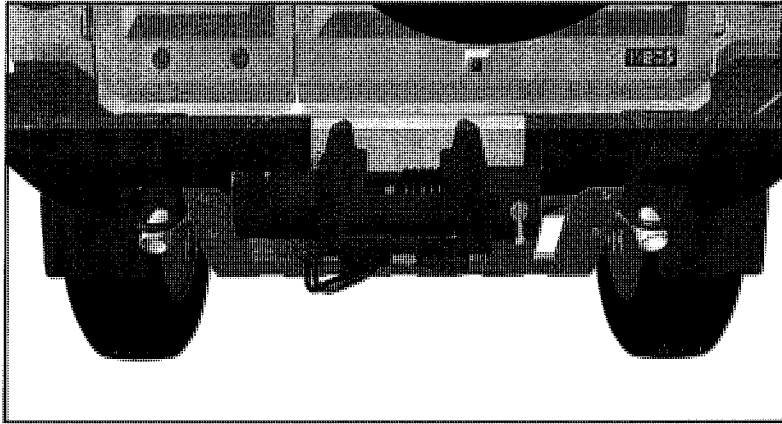

WINCH OPERATION - REMOTE CONTROL

WINCH REMOTE CONTROL OPERATION



WARNING: Keep the batteries out of reach from children. If you think batteries may have been swallowed or placed inside any part of the body, seek immediate medical attention.



NOTE: The Winch Remote Control is IP67 rated.

The Winch Remote Control consists of three buttons and one Light-Emitting Diode (LED).

1. Power Button
2. LED
3. Winch In
4. Winch Out

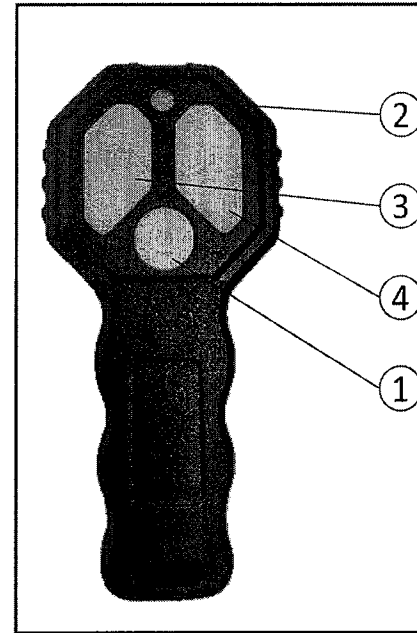

NOTE: The Winch Remote Control requires 2x AAA (3v) batteries.



NOTE: Batteries should be disposed of at an appropriate recycling point. Do not dispose of old batteries in household waste. Dispose of old batteries in accordance with environmental regulations.

WINCH OPERATION - REMOTE CONTROL

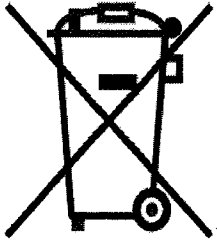

TURNING THE WINCH REMOTE CONTROL ON/OFF

Press and hold the Power Button (1), for three seconds, to turn the Winch Remote Control ON and connect to the Winch.

Quick press once, to turn the Winch Remote Control OFF.

LED

When the transmitter matches with the receiver, the LED will be illuminated. When the Winch Remote Control is communicating the LED will flicker.



NOTE: If a vehicle is fitted with a Front Integrated Heavy Duty Winch and a Removable Rear Winch, it is strongly recommended that the individual Winch Remote Controls are marked to state which Winch they control.

WINCH OPERATION - REMOTE CONTROL PAIRING

PAIRING



WARNING: Never pair the Winch Remote Control to more than one Winch simultaneously, this could cause unexpected Winch behaviour and could lead to serious injury and or damage to the Winch and vehicle.



WARNING: Never use the Front Integrated Heavy Duty Winch and Removable Rear Winch at the same time.



WARNING: High amp outlet (NATO outlet) live, do not touch terminals. Failure to do so can result in serious injury and/or death.



WARNING: Do not plug any cables into a live power outlet, if the vehicle has been driven in the rain and/or been taken wading without the power outlet cover being fully closed.



CAUTION: Always check rear high amp outlet (NATO outlet) cover is fully closed before and after winch use. Ensure high amp (NATO outlet) cover is fully closed before taking vehicle wading.

If one Winch is fitted to the vehicle (Front Integrated Heavy Duty Winch OR Removable Rear Winch):

When the Winch is switched ON, the Winch Remote Control will be in pairing mode for five seconds. Ensure there is no other Winch switched ON simultaneously, in the vicinity.

1. Start the engine.
2. Engage Neutral (N) and the handbrake.
3. Check the Winch isolator in the Overhead Control Panel is set to OFF.
4. Switch the Winch Remote Control ON.
5. Hold the IN and OUT buttons on the Winch Remote Control simultaneously.
6. Switch the Winch isolator in the Overhead Control Panel to ON.
7. Continue to hold the IN and OUT buttons on the Winch Remote Control simultaneously, for three seconds.
8. Release the IN and OUT buttons on the Winch Remote Control.
9. Test the Winch Remote Control functionality.

If there is more than one Winch fitted to the vehicle (Front Integrated Heavy Duty Winch AND Removable Rear Winch):

To pair the Front Integrated Heavy Duty Winch, disconnect the Removable Rear Winch power cable from the vehicle, and follow the previous instructions.

WINCH OPERATION - REMOTE CONTROL PAIRING

To pair the Removable Rear Winch, follow the instructions below:

1. Disconnect the Removable Rear Winch power cable.
2. Start the Engine.
3. Engage Neutral (N) and the handbrake.
4. Switch ON the Winch isolator in the Overhead Control Panel. Wait for one minute to allow the Front Integrated Heavy Duty Winch control unit to exit Winch Remote Control pairing mode.
5. Switch the Winch Remote Control for the Rear Removable Winch to ON.
6. Hold the IN and OUT buttons on the Winch Remote Control for the Removable Rear Winch simultaneously.
7. Connect the Removable Rear Winch power cable to the vehicle outlet.
8. Continue to hold the IN and OUT buttons simultaneously for three seconds on the Winch Remote Control.
9. Release the IN and OUT buttons on the Winch Remote control.
10. Test the Winch Remote Control functionality.

WINCH OPERATION

STEP-BY-STEP GUIDE

1. Start the engine.

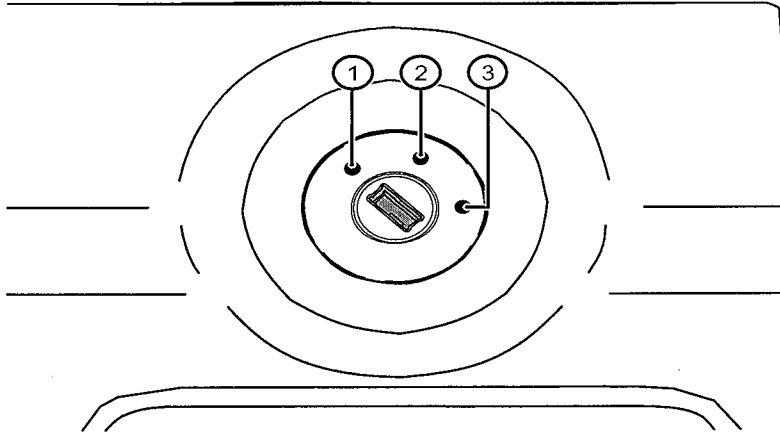

Apply pressure to the foot brake, turn the key to position (3) until engine starts. Once the engine has started, release the key. This will allow the key to rotate back to position (2).

To turn off the ignition, turn the key back to position (1).



WARNING: The engine can be started by any person in the vehicle when the key is in the ignition and the foot brake is applied. The vehicle should not be left unattended with the key present and occupants, such as, young children inside.



WARNING: Make sure the handbrake is applied and the transmission is in park P. This will prevent the vehicle from moving once the engine is started.



CAUTION: In extreme low temperatures (-20°C and below), do not run the engine above 4000 rpm, while at standstill or when moving off, until the coolant temperature gauge reaches normal operating temperature. If you do, there is a risk of damage to the engine.

2. Switch the 500A isolator ON

Toggle the optional 500A switch located in the High Load Auxiliary Switch Panel to the ON position. The High Load Auxiliary Switch Panel is an optional bank of switches located in the Overhead Control Panel. An orange LED will illuminate on the isolator switch when it is active.

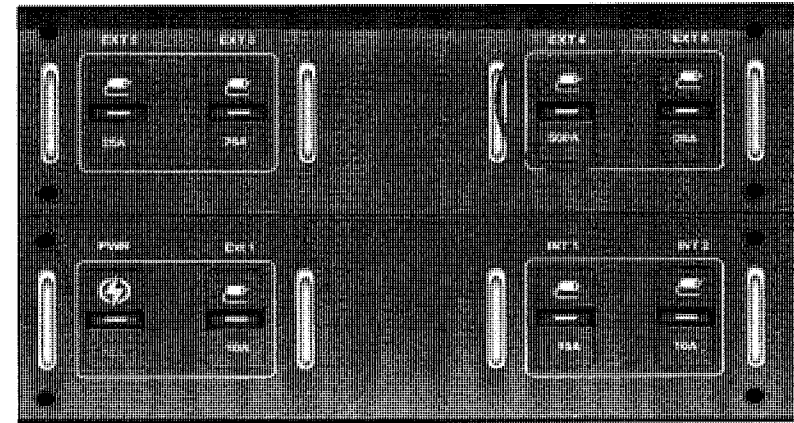

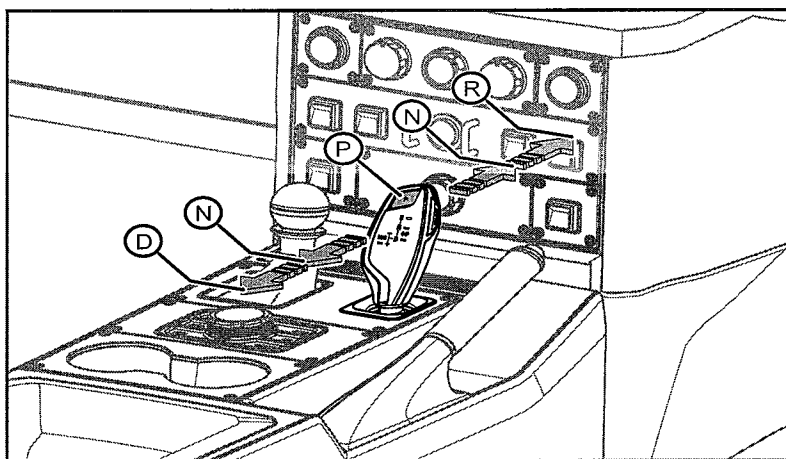

WINCH OPERATION

- Using the gear selector, put the transmission into position N and engage the handbrake.

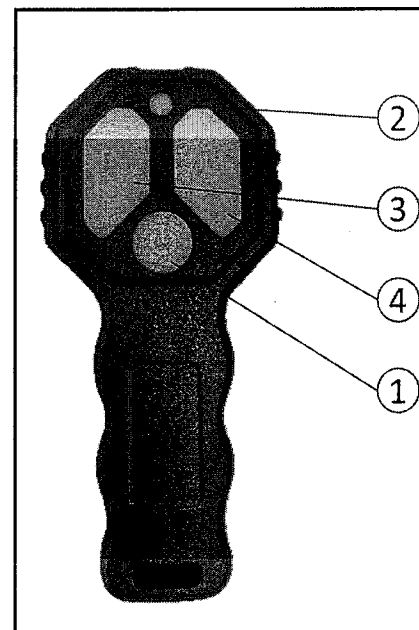

- Hold the Power Button (1), for three seconds to switch ON the Winch Remote Control. The LED (2), will illuminate when the Winch Remote Control is active.



-  *NOTE: The Power Button (1), on the Winch Remote Control has to be pressed for three seconds in order to switch it ON, thus preventing accidental activation.*
-  *NOTE: Once the Winch Remote Control is ON, the Power Button (1) can be pressed to immediately switch OFF the Winch Remote Control.*

WINCH OPERATION

5. The Freespool Lever should be in a horizontal position, secured against the highest part of the cam extrusion. When in this position, the Freespool Lever is engaged.

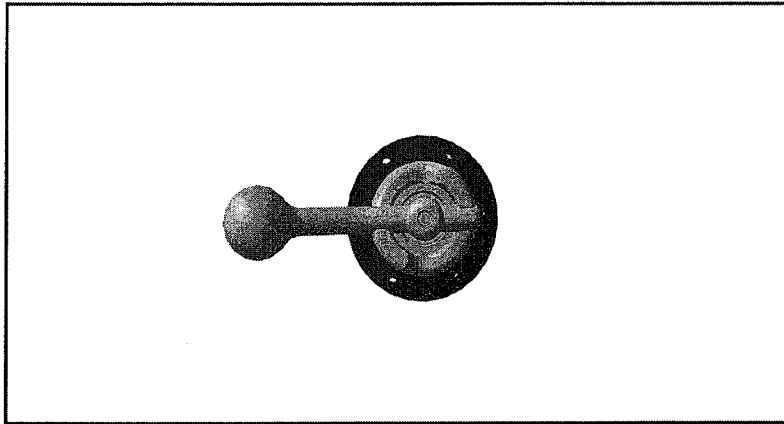

NOTE: If not fully secure against the highest part of the cam extrusion, pull the Winch Rope out a little by hand to turn the drum. Turning the drum will allow the Freespool Lever to correctly mesh with the internal mechanism and in turn, the lever will locate against the highest part of the cam extrusion.

6. With the Freespool Lever now engaged, pull the Winch Rope out to its maximum extension and secure the Winch Rope to either an object or anchor point.



CAUTION: Always ensure that a Snatch Ring (RED Winch S-Ring 50), is inserted into the soft loop at the end of the Winch Rope.

7. Turn the Freespool Lever 90° clockwise, to disengage Freespool. In doing this the Winch Drum becomes engaged with the motor.

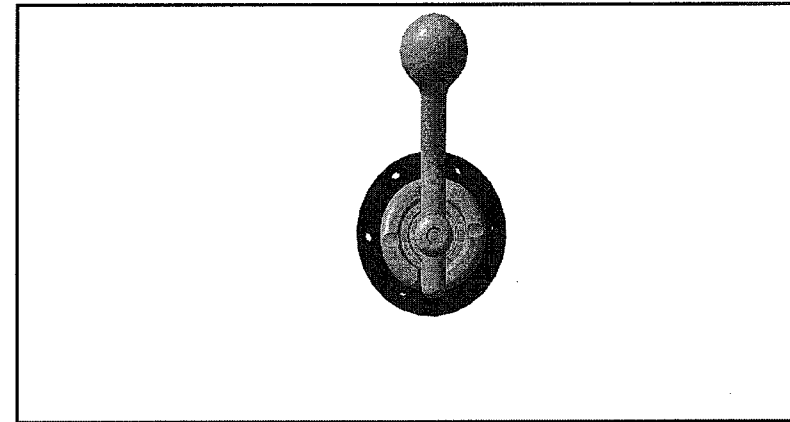

Check that the Freespool Lever is in a vertical position, secured against the lowest part of the cam extrusion.

8. Slowly spool in the Winch to pretension the Winch Rope.

WINCH OPERATION

9. To move the vehicle while operating the Winch, disengage the handbrake and set the transmission to **N**, **R**, or **D**.

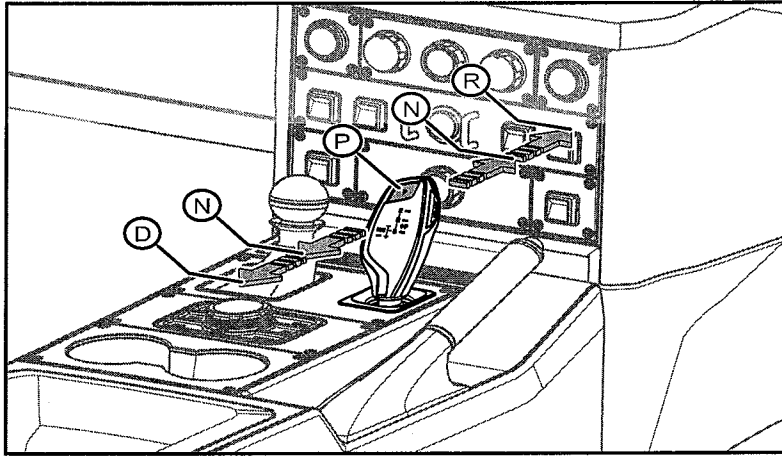

10. Operate the Winch with the Winch Remote Control. Press button **(3)** to spool in. Press button **(4)** to spool out.

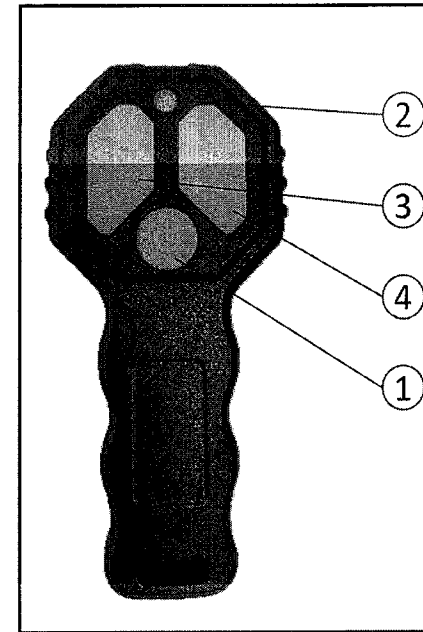

WINCH OPERATION

11. After the vehicle has been recovered, the transmission should be put into N and the handbrake should be engaged.

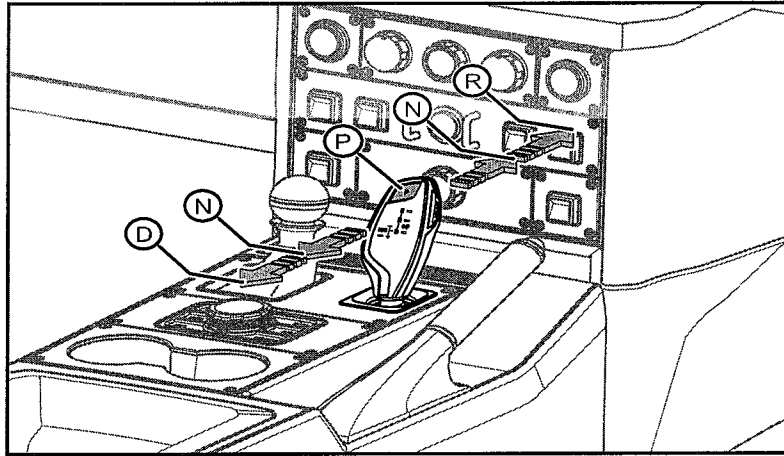

12. Release the tension on the Winch Rope and safely remove it from the object or anchor point.
13. Upon completion of the Winch operation, wind the Winch Rope back in.



WARNING: Be careful when operating the winch not to entangle any long hair and/or clothing in the Winch Rope. Take care not to entangle any jewellery and/or materials such as, rags in the Winch Rope, as it meets the Fairlead. Failure to do so may result in serious injury or even death.



WARNING: Always use extreme caution when handling the Winch Rope during spooling operations. Failure to do so can lead to serious injury or even death.



WARNING: There is a delay between releasing the button on the Winch Remote Control and the rotating Winch Drum stopping. Do not touch the Winch or Winch Rope, until the Winch has completely stopped moving.



WARNING: There is a high risk of injury while the Winch Drum slows down, stay alert.

14. Switch OFF the Winch Remote Control and then switch OFF the 500A isolation switch, located in the Overhead Control Panel. The orange LED will no longer be visible when the isolator switch is inactive.



NOTE: It is possible to unwind the Winch Rope using the Winch Remote Control (without using Freespool). The Winch Rope must be under light tension, then use the Winch Remote Control to spool out.

ADDITIONAL INFORMATION



NOTE: Press the Power Button (1) for three seconds to switch ON the Winch Remote Control. The Power Button must be pressed for a minimum of three seconds, to avoid accidental pairing and/or operation.

WINCH OPERATION



NOTE: When the Winch Remote Control is set to ON, pressing the Power Button will stop the Winch function immediately. However, the Winch Drum may continue to rotate under its own momentum.

SERVICE INFORMATION

SERVICING YOUR WINCH

The Front Integrated Heavy Duty Winch and/or the Removable Rear Winch will require periodic servicing dependant on the frequency of use. Usage falls into three categories, Infrequent Use, Standard Use and Frequent Use. These categories are determined by how many hours of constant running time the Winch has undertaken.

INFREQUENT USE: If the Winch is used for less than 25 hours per year, then it should be serviced every 3 years.

STANDARD USE: If the Winch is used for between 25-50 hours per year (around 10 Winch pulls per week), then it should be serviced every 2 years.

FREQUENT USE: If the Winch is used for over 50 hours per year (around 20 Winch pulls per week), it should be serviced every year.



WARNING: Always ensure the Winch service intervals have been adhered to before any Winch operation. Failure to do this, may result in damage to the vehicle, Winch and/or the Winch Rope. This may result in serious injury and/or death to the operator and/or people nearby.



NOTE: Take note of each Winch use and record the hours of running time in the "NOTES" section, at the end of the book. A log will allow you to understand your

frequency of use to keep the Front Integrated Heavy Duty Winch and/or Removable Rear Winch maintained.

HOW TO SERVICE YOUR WINCH

RED Winches, offer different alternatives to service your Winch:

> Contacting one of the official RED Winches distributors:

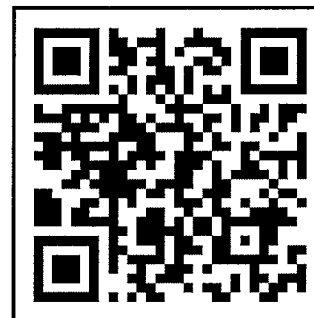

> Alternatively, RED Winches offer the service to have your Winch serviced at their headquarters in the UK. Please contact RED Winches for further information:

Email: sales@red-winch.com

Phone: +44 (0)1460 297 355

FREQUENTLY ASKED QUESTIONS

GENERAL MAINTENANCE

-  **WARNING:** Do not pressure wash the Winch. Pressure washing the Winch can force water between the seals and gaskets. This may result in the Winch failing during operation.

- Check the battery regularly. Ensure that it is in good condition and is fully charged.

- Check that all of the connections are clean and tight. Corrosion on the battery connections can affect the performance of the Winch. Ensure that the battery connections are tight.

- The Winch is protected from water and rain, but avoid submerging the Winch for a prolonged time, particularly if the Winch casing is warm / hot.

- If the Winch does become submerged, once clear, run the Winch in and out for about ten meters of Winch Rope to generate heat inside the Winch, to help dry the inside of the casing.

- Only use soap and water to clean the Winch. **DO NOT PRESSURE WASH THE WINCH.** This can force water past the seals and gaskets.

- If you were not the last person to use the Winch, always inspect the full length of the Winch Rope before applying any load to it.

- The Winch must be serviced regularly at an authorised RED Winch Centre / Partner / Distributor.

- See service record sheet at the back of this manual.

BASIC TROUBLE SHOOTING

The Winch only operates in one direction:

- This may be due to a faulty solenoid, damaged Winch Remote Control. Check that the Winch Remote Control is paired and connected correctly.

The Winch is completely dead:

- This may be due to a burned out motor, poor earth, discharged battery, faulty isolator switch, damaged earth wire, damaged Winch Remote Control, damaged cable or damaged switch. Check the isolator switch is set to ON. Check if there is power getting to the Winch. Check that the gear selector in the vehicle is not in P.

The Winch has low power:

- Check the condition of the vehicle battery and check that the alternator is charging correctly, check the voltage to the battery. Check if the battery terminals are corroded or the cables are damaged.

- Turn off any electrical items in the vehicle; Radio, Lamps, Heated Seats etc.

FREQUENTLY ASKED QUESTIONS

The Winch will not Freespool:

- This may be due to a warped mount plate, Winch Rope may be bound up on one side of the Winch Drum, there may be damage to the Winch Drum flange or gears inside the Winch.
- Check that the Freespool Lever is free to move and can be disengaged.

The Winch motor gets hot very quickly:

- Overloaded or stalled during Winching operation. Poor earth connection to the battery, worn Winch motor, water or mud in the Winch motor. Check that the load does not exceed the Winches load rating. Check all connections and cables.

The Winch Brake will not hold:

- Worn friction material or the Winch brake has overheated from an extended period of power out.



NOTE: These notes are general guidelines only. Use your own judgment to best determine when the Winch needs to be serviced based on the activities where the Winch has been used.



NOTE: Please contact Red Winches if you are experiencing any difficulties, including any of the guidelines listed in the 'Basic Trouble Shooting' Section.

Email: sales@red-winch.com Phone: +44 (0)1460 297 355

WINCH HAS NO POWER

1. Check the Winch isolator is switched ON. The 500A switch is located on the Overhead Control Panel, inside the vehicle cabin.
2. Check the battery status of the vehicle. The vehicle battery must be above 55% to power the Winch. If the battery is below 50%, then the Winch will automatically be deactivated.
3. Check the continuity between the terminals of the 150A circuit breaker, located in the engine compartment.
4. Check the cable connections on the Winch motor, underneath the front and rear of the vehicle.
5. Check the motor control solenoid is functioning, located inside the front right wing of the vehicle, behind the right headlight.

FREQUENTLY ASKED QUESTIONS

WINCH ONLY ROTATES IN ONE DIRECTION

1. Check the motor control solenoid is functioning and the cable connections on the unit are secure, located inside the front right wing of the vehicle, behind the right. This unit controls the direction of the Winch motor.
2. Check the cable connections on the Winch motor.
3. Check the Winch motor has not been damaged during a stall or is suffering from an electrical fault.

WINCH WILL NOT WINCH IN OR OUT

1. Check the Winch Remote Control is paired and connected to the Winch's wireless receiver, located within the Winch control unit inside the vehicle. If not, follow the pairing instructions found in the 'Winch Operation - Winch Remote Control Pairing.' section of this user manual.
2. Check that the Freespool Lever is in the engaged position. The Freespool Lever should be positioned horizontally and secured against the highest part of the cam extrusion. If the Freespool Lever is not fully secured against the highest part of the cam extrusion, then pull the Winch Rope out a little by hand to turn the Winch Drum. Turning the Winch Drum, will allow the Freespool lever to correctly lock into place with the internal mechanism, and in turn, locate against the highest part of the cam extrusion.

3. Check the Winch Rope is not slipping on the Winch Drum. If the Winch Rope is slipping, stop all operation and wait for the Winch Drum to stop moving. Once the Winch Drum has stopped moving and it is safe to handle, pull the Winch Rope out until the red mark and rewind with higher tension.
4. Check no foreign objects have jammed the Winch Drum and that the Winch Rope is not bound tight against a part of the vehicle.
5. Check the Winch motor has not been damaged during a stall or is suffering from an electrical fault.

FREQUENTLY ASKED QUESTIONS

WINCH IS LACKING PULLING POWER

1. Check that the Freespool Lever is in the engaged position. The Freespool Lever should be positioned horizontally and secured against the highest part of the cam extrusion. If the Freespool Lever is not fully secured against the highest part of the cam extrusion, then pull the Winch Rope out a little by hand to turn the Winch Drum. Turning the Winch Drum, will allow the Freespool lever to correctly lock into place with the internal mechanism, and in turn, locate against the highest part of the cam extrusion.
2. Check the Winch Rope is not slipping on the Winch Drum. If the Winch Rope is slipping, stop all operation and wait for the Winch Drum to stop moving. Once the Winch Drum has stopped moving and it is safe to handle, pull the Winch Rope out until the red mark and rewind with higher tension.
3. Check that the alternator is charging the vehicle battery and ensure the vehicle battery has sufficient charge. A drained battery will prevent the Winch from pulling with full power.

WINCH STOPS SUDDENLY WHILE WINCHING

1. Check the continuity between the terminals of the 150A circuit breaker, located in the engine compartment. The circuit breaker calculates the current draw over time. If

too many amps are drawn by the Winch, then the breaker will trip and cut power to the Winch.

2. Isolate the Winch and leave for five minutes with the vehicle's engine is running. This will allow the circuit breaker to self-reset, while the vehicle batteries regain charge.

WINCH WILL NOT FREESPOOL

1. Check the Freespool Lever is situated in the released position. The Freespool Lever, should be in a vertical position, secured against the lowest part of the cam extrusion. The Freespool operation requires the Winch Drum to move, so you must check the Winch Drum can rotate freely, as you pull the Winch Rope out.
2. Check that there are no foreign objects trapped in or around the Winch Drum and that the Winch Rope is not bound tight against the vehicle. If the Winch Rope is bunching and becoming difficult to pull out, locate the Freespool Lever into the engaged position and then Winch out for the first for two metres. After freeing the Winch Rope, relocate the Freespool Lever into the released position and continue to Freespool.
3. If there is damage to the Winch mounting plate, then this can result in the Winch mounting plate becoming twisted. This in turn may result in the Winch Drum becoming tight and unable to Freespool.

FREQUENTLY ASKED QUESTIONS

WINCH WILL NOT HOLD VEHICLE WEIGHT



WARNING: When operating the Winch from the driver seat, do not spool the Winch out further than the red marker. Beyond this point, the Plasma Lock will not create sufficient friction.

The Winch will hold the vehicle and/or load, if the Winch pull is stopped, while Winching the vehicle and/or load up or down an incline. So long as, the force on the Winch and supplementary equipment is within the load ratings of all the equipment being utilised. If it does not:

1. Check the Winch Rope is not slipping on the Winch Drum. If the Winch Rope is slipping, stop all operation and wait for the Winch Drum to stop moving. Once the Winch Drum has stopped moving and it is safe to handle, pull the Winch Rope out until the red mark and rewind with higher tension.
2. When lowering the vehicle and/or a load down a slope, make sure you are vigilant and do the following:
 - If you see the red marker on the Winch Rope when operating from the DRIVER SEAT, then you **MUST STOP** immediately.
 - If you see the Plasma Lock between the Winch Rope and the Winch Drum, then you **MUST STOP** immediately.

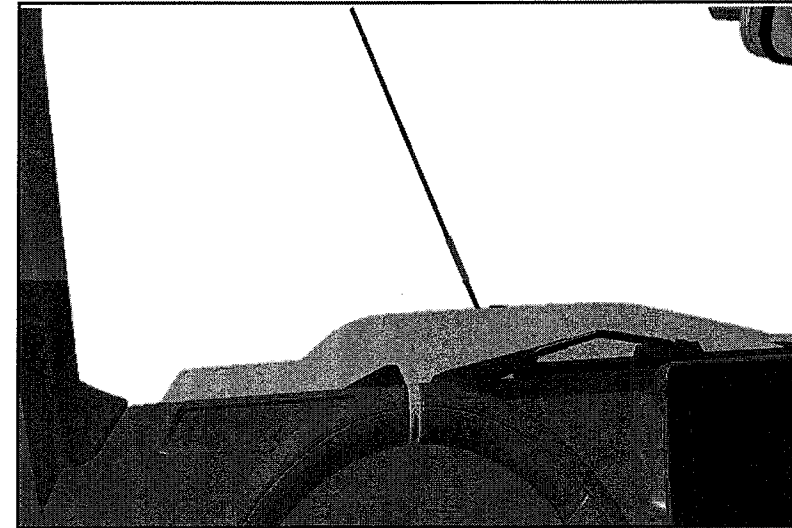

If you see either of the above, then the Winch Rope has reached its maximum extension length. The friction effect between the Winch Rope and Winch Drum will start to fail, if the Winch Rope is spooled out any further.



NOTE: The Plasma Lock is the locking device that secures the Winch Rope to the Winch Drum with tension and friction.

The Plasma Lock has two loops, one at each end. The Winch Rope goes through the first loop (1) and then wraps over the body of

FREQUENTLY ASKED QUESTIONS

the plasma lock (2) four times, before being inserted into the opposite loop (3).

The following image shows the Plasma Lock with the Winch Rope inserted through first loop (1) and then one wrap of the Winch Rope around the Winch Drum and over the Plasma Lock (2).

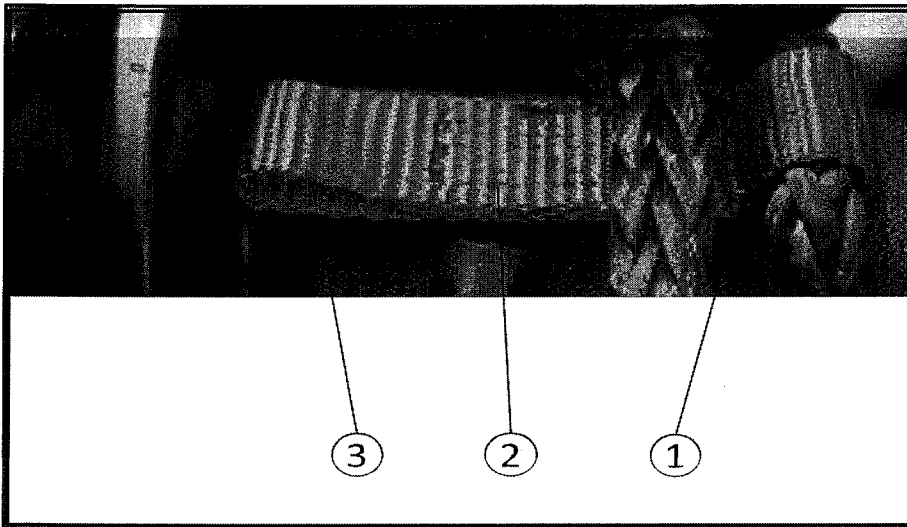

Winch Rope tail inserted through second loop of the Plasma Lock(3).

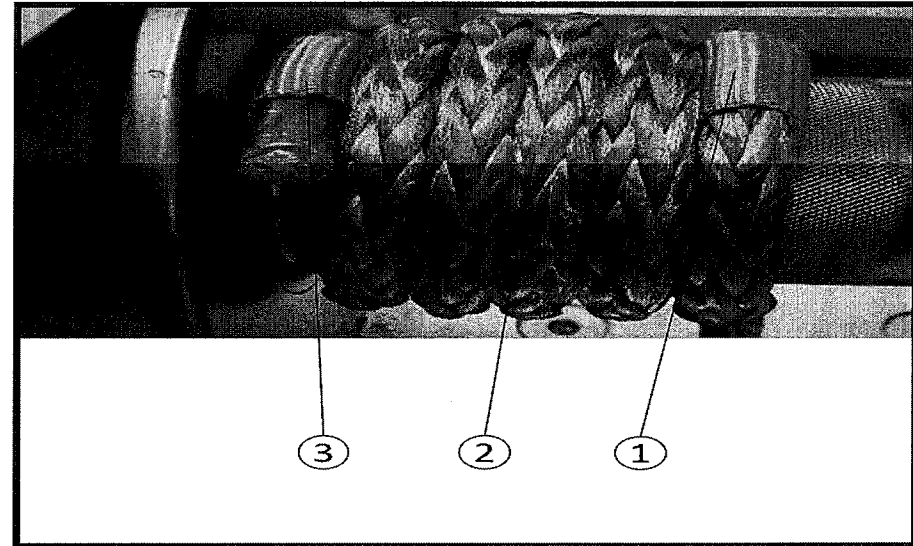

The following image shows the Plasma Lock fully engaged with the Winch Rope inserted (1). You can see the Winch Rope wrapped around the Winch Drum and Plasma Lock four times (2) with the

FREQUENTLY ASKED QUESTIONS

WINCH LOAD LIMITS

Please refer to the following images for the Winch load limits:

